

Pos.Nr. Pos.no. Position	Beschreibung Description Désignation	Preisgruppe Price bracket Catégorie de prix	
		Art.-Nr. Art.no. Réf.	
1	Motor	85112	57
2	GF Schraube M 2X5	114966	2
3	FK-Schraube m. Gewindeauslauf	85704	3
4	Beilagscheiben	86108	2
5	Feder	86202	2
6	Zugfeder	86208	2
7	Zahnrad Z=19/14	86416	3
8	Zahnrad	86418	2
9	Schnecke Z-1/M-0.4	86703	4
10	Kardanwelle	87122	2
11	Kardanschale kurz	87129	3
12	Kardanschale 8,0 MM	87152	2
13	Motorplatine	87861	38
14	Hafringsatz 10Stk. 10,3-12,8	40069	---
15	Puffer gewölbt	88503	4
16	Universalkupplung	89282	5
17	Lager für Schneckenachse	89749	6
18	Radkontakt	89918	5
19	Brückenstecker	100644	7
20	Distanzplättchen	105764	2
21	Attrappenrahmen klein	107808	3
22	Teilesatz	108322	8
23	Drahtlampe T3/4 16V 30mA	108616	10
24	Zahnrad Z=23	111679	2
25	Lichtnagel rot	112173	2
26	Schneckendeckel mit Stab.Feder	112897	8
27	Lichtnagel weiß	112940	2
28	Grundrahmen	114710	30
29	Teilesatz	114888	8
30	Unterflurgerät o. Indusi	114889	2
32	Teilesatz	114890	10
33	Lampen-Flexplatine	114715	27
34	Schneckensatz kpl.	114716	24
35	Gehäuse kpl.	114891	62
36	Zurüstbeutel	114892	28
37	Blende DC	114894	20
38	Getriebeteilesatz	114895	24
39	Radsatz o. Haftring m. Zahnrad	114896	18
40	Radsatz m. 2 Haftringen	114897	20
41	Teilesatz	114723	14
42	Teilesatz	114724	5
43	Teilesatz	114898	5
44	Teilesatz	114726	10
45	Teilesatz	114727	5
46	Teilesatz	114728	5
47	GF-Schraube M2X6	114828	2
48	Tafelsatz lack.	114893	20
49	Stirntrittbrett	114899	2
Abweichende Teile 63901 Sound			
50	Lautsprecherhalter	114730	2
Wechselstrom AC ~			
51	AC-Flüsterschleifer kurz	40064	---
52	Hafrings.10Stk. 10,3-12,4mm	40074	---
53	HO-Radsatz AC	114901	6
54	Schleiferhalter	95687	5
55	Blende AC	114900	20
56	Radsatz m. 2 Haftringen	115122	20

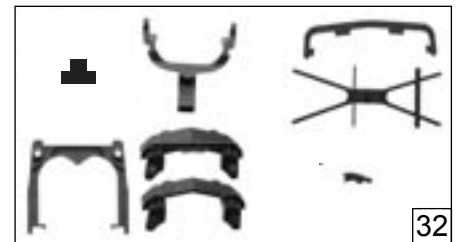

48 o. Abb. / no ill.
Tafelsatz lack.
Number set

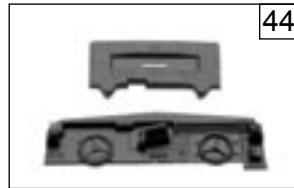
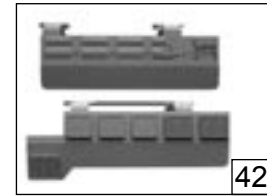
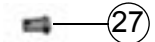
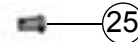
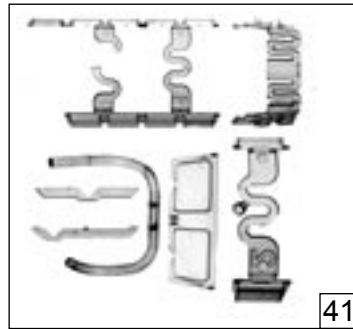
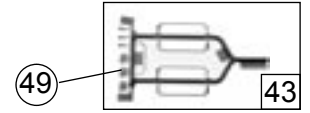
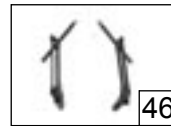
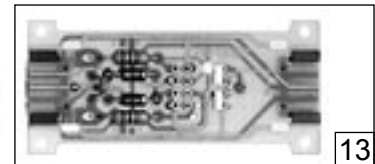
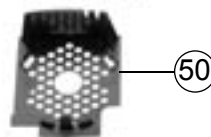
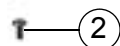
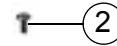

Pos.Nr. Pos.no. Position	Beschreibung Description Désignation	Preisgruppe Price bracket Catégorie de prix	Art.-Nr. Art.no. Réf.	
1	Motor		85112	57
2	Screw M 2x5		114966	2
3	FK-Screw with back taper thread		85704	3
4	Plate		86108	2
5	Spring		86202	2
6	Spring		86208	2
7	Gear z=19/14		86416	3
8	Gear		86418	2
9	Worm Z-1/M-0,4		86703	4
10	Cardan Shaft		87122	2
11	Cardan shell short		87129	3
12	Cardan Shaft		87152	2
13	Printed circuit for Motor		87861	38
14	Traction tires set 10Stk. 10,3-12,8		40069	---
15	Buffer vaulted		88503	4
16	Universal coupling		89282	5
17	Bearing for Worm axle		89749	6
18	Wheel contact		89918	5
19	Connector		100644	7
20	Spacer		105764	2
21	Push in part set, small		107808	3
22	Parts set		108322	8
23	Bulb T3/4 16V 30mA		108616	10
24	Gear z=23		111679	2
25	Lens red		112173	2
26	Wormcover with vibration damper		112897	8
27	Light nail white		112940	2
28	Main frame		114710	30
29	Parts set		114888	8
30	Underfloor device with indusi		114889	2
32	Parts set		114890	10
33	Flexible Printed circuit for bulbs		114715	27
34	Worm set ass.		114716	24
35	Casing assembly		114891	62
36	Bag with accessories		114892	28
37	Bogie DC		114894	20
38	Gear part		114895	24
39	Wheelset without traction tire with gear		114896	18
40	Wheelset with 2 traction tires		114897	20
41	Parts set		114723	14
42	Parts set		114724	5
43	Parts set		114898	5
44	Parts set		114726	10
45	Parts set		114727	5
46	Parts set		114728	5
47	Screw thread gouging		114828	2
48	Number set		114893	20
49	Step		114899	2
Variant Parts 63901 Sound				
50	Loud speaker holder		114730	2
~ AC Wechselstrom 69901 Sound				
51	Wisper wiper, short		40064	---
52	Traction tires set 10Stk. 10,3-12,4		40074	---
53	HO-Wheelset AC		114901	6
54	Grinder holder		95687	5
55	Bogie AC		114900	20
56	Wheelset with 2 traction tires		115122	20

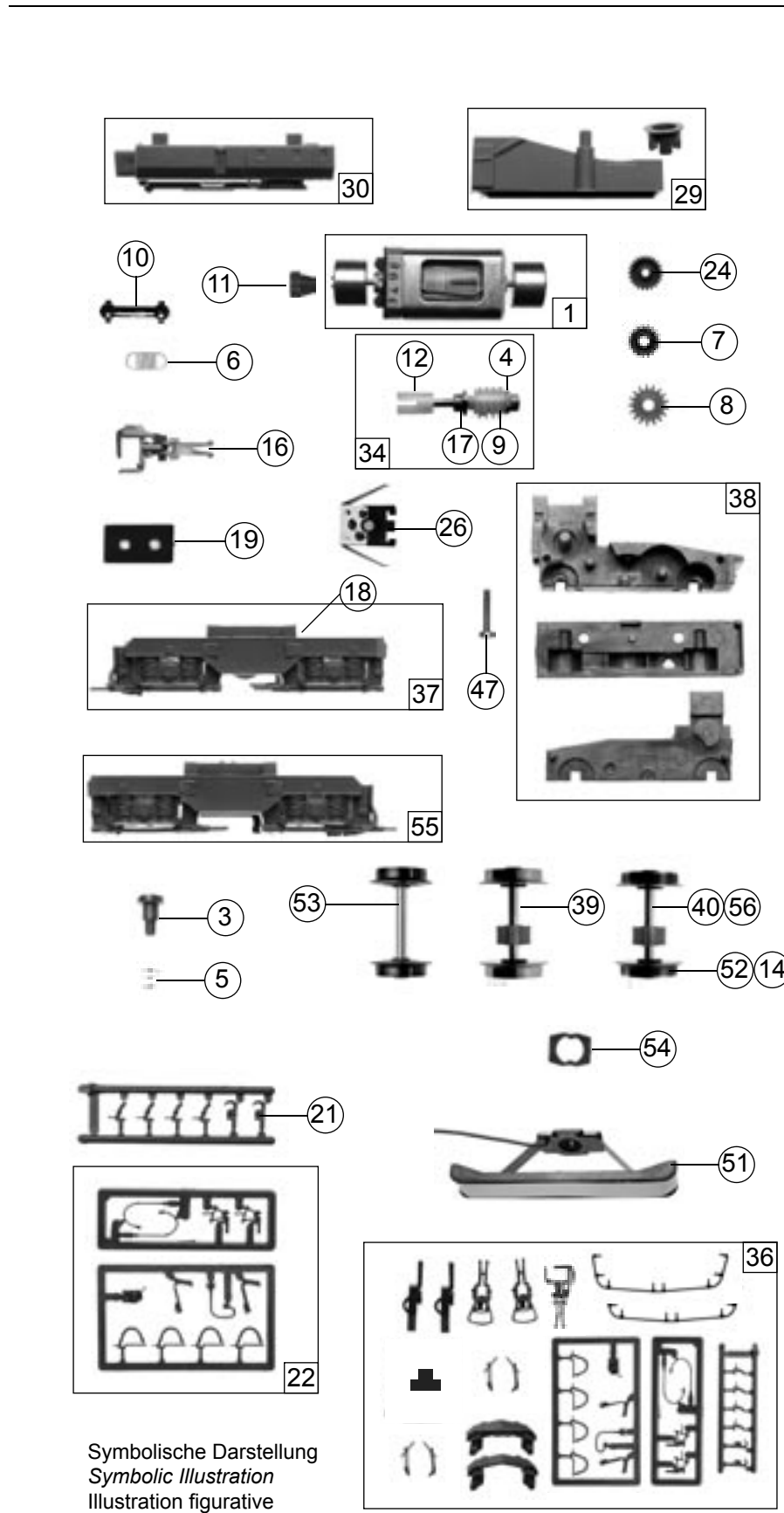

Symbolische Darstellung
Symbolic Illustration
Illustration figurative

Ersatzteile erhalten Sie bei Ihrem Fachhändler, Ihrer Landesvertretung, oder bei:
You can order your Replacement Parts at your local dealer, your country representative, or:
Passez commande des pièces détachées chez votre détaillant, chez le S.A.V. de votre importateur national ou en direct au S.A.V. ROCO:

ROCO Modellspielwaren VertriebsgmbH & Co. Handels KG
— Service —
Georg-Wrede-Straße 49, D-83395 Freilassing
☎ +49 / (0)86 54 / 47 63 0
Fax: +49 / (0)86 54 / 47 63 50
E-Mail: service@roco-online.de